



TMI



ED 01 - MY 06/10

Wall Ties & Restraint Fixings

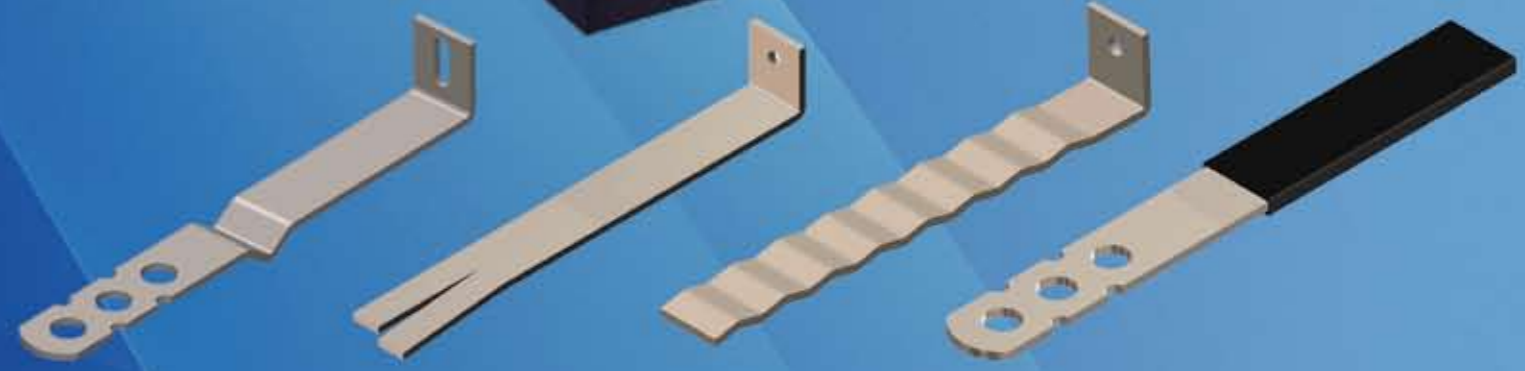

Table of CONTENTS

Introduction	3
Frame Cramps	5
Movement Ties	6
Cavity Wall Ties	7
Overhead Restraints	9
Channels	11
Dove Tail Anchor channels	12
Sliding Anchor Systems	13
Wall Ties Guide	14
Technical Specifications	15
Storage Conditions	15



Technical Metal Industrial Co. L.L.C.

Tel: +971 (2) 5502025
 Fax: +971 (2) 5502024
 P.O. Box: 41558
 Abu Dhabi

Tel: +971 (3) 7224768
 Fax: +971 (3) 7224769
 P.O. Box: 99155
 Al Ain

Tel: +971 (4) 8858036
 Fax: +971 (4) 8858658
 P.O. Box: 86029
 Dubai

Tel: +971 (7) 2282332
 Fax: +971 (7) 2282232
 P.O. Box: 33239
 Ras Al khaimah

E-mail: tmi@tmico.ae Website: www.tmi-co.com

Introduction

TMI has been in the business of manufacturing and supplying a wide range of building accessories for the construction industry since 1997. With continued process improvement and new innovative product development, *TMI* is proud to deliver any quantity of its high quality and great valued products, with excellent service and punctuality to its customers.



TMI is well equipped for manufacturing wall ties and meeting any challenge in the construction industry. *TMI* manufactures a wide range of wall ties in galvanized steel and stainless steel of grades S304 and S316.

The range of *TMI's* accessories from the standard ties, to its specialty, the custom designed ties are available to suit most engineering applications such as masonry to masonry, masonry to concrete, masonry to overhead structure and masonry to steel structures.

All wall tie's manufacturing complies with BS EN 845-1:2003 (formerly BS 1243). A quick quotation and prompt delivery is available from stock of standard tie. As for our custom designed ties, an advanced information submittal is required for quick deliveries.

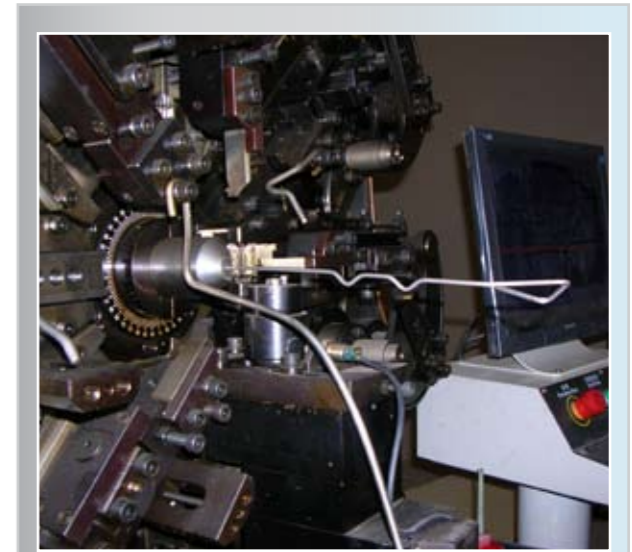

Frame Cramps

Application

Frame cramps are designed to restrain the masonry with the new or existing vertical structure.

Fixing

The Ø6mm hole (as in LPS) or 6mmx18mm slot (as in LPT) in the standard 30mm upstand (other upstand height available upon request) is provided for attaching the frame cramp to the vertical structure and the other end is embedded to the masonry.

Length mm	Width mm	Thickness mm	Qty./Box Piece
75	20 up to 50	1.5/2.0/2.5/3.0	250
100	20 up to 50	1.5/2.0/2.5/3.0	250
125	20 up to 50	1.5/2.0/2.5/3.0	250
150	20 up to 50	1.5/2.0/2.5/3.0	250
175	20 up to 50	1.5/2.0/2.5/3.0	250
200	20 up to 50	1.5/2.0/2.5/3.0	250
225	20 up to 50	1.5/2.0/2.5/3.0	250
250	20 up to 50	1.5/2.0/2.5/3.0	250



- * Custom designs are available upon request.
- * Material - Galvanized, Stainless steel, mild steel.
- * Finish - Hotdip galvanized, Powder coated

LSS

L-Bolt/Screw-on Split End

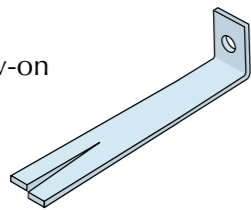

LSS-ST

L-Slot tie with Split-end

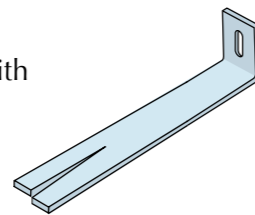

LBT

L-Bolt tie with u-cut end

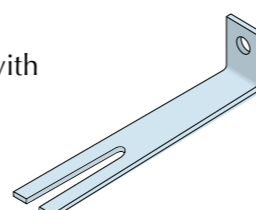

LST

L-Slot tie with u-cut end

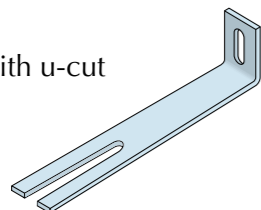

LPS-S

L-Perforated special tie bolt/screw-on

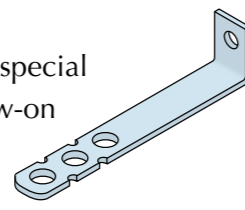

LPS-ST

L-Perforated special slot tie

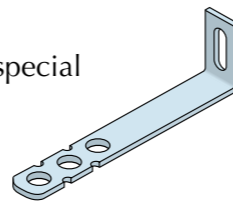

CGWT

Corrugated bolt wall tie

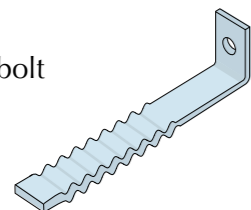

LSSF

L-Bolt screw-on safety

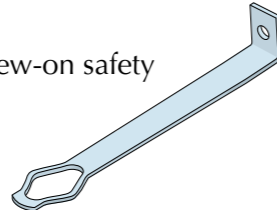

LSSB

Bolt screw-on flat split-bend tie

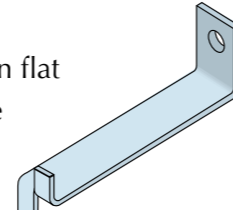

LSSB-ST

Slot flat split-bend tie

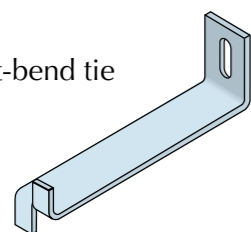

LPS

L-Plain bolt/screw-on tie

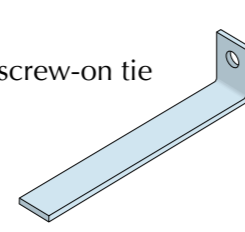

LPT

L-Plain slot tie

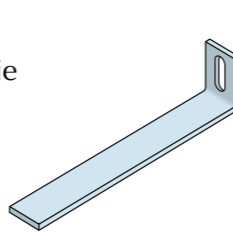

Movement Ties

Application

Movement ties are designed to restrain masonry against lateral wind loads, allowing a horizontal expansion or contraction. Movement ties are used where masonry restrained to steel work and in long span masonry where movement joints are required.

Fixing

Movement ties are held in the brick or block work. The debonding sleeve provided on plain end of the tie will serve to allow the movement. *TMI* recommends the debonding sleeve to be installed with a gap of 10mm at the end to allow for expansion or contraction.

Length mm	Width mm	Thickness mm	Qty./Box Piece
75	25 up to 30	1.5/2.0/2.5	250
100	25 up to 30	1.5/2.0/2.5	250
125	25 up to 30	1.5/2.0/2.5	250
150	25 up to 30	1.5/2.0/2.5	250
175	25 up to 30	1.5/2.0/2.5	250
200	25 up to 30	1.5/2.0/2.5	250
225	25 up to 30	1.5/2.0/2.5	250
250	25 up to 30	1.5/2.0/2.5	250



- * Custom designs are available upon request.
- * Material - Galvanized, Stainless steel, mild steel.
- * Finish - Hotdip galvanized, Powder coated

LPSW

L-plain tie bolt /screw-on with sleeves

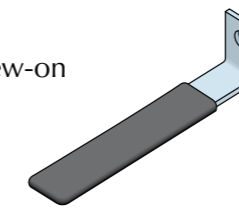

LPSW-ST

L-Plain tie slot with sleeves

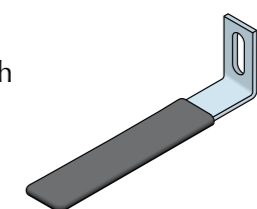

PTSW

Perforated tie special with sleeves

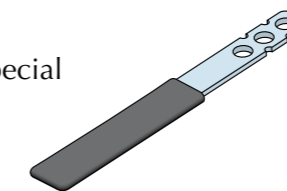

FTSW

Flat tie with sleeves

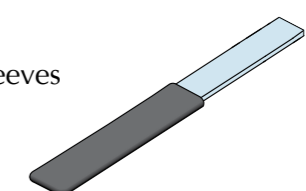

DBS

Debonding sleeve

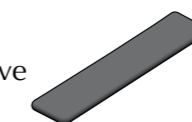

- * Debonding sleeve is supplied according to tie measurement.

Cavity Wall Ties

Application

These products are designed to secure two masonry of a cavity wall, allowing them to act as one structure.

Fixing

The tie made of strip (as in FCWT) or wire (as in WTB) is embedded in the inner and outer masonry. Ties having a $\varnothing 6.0\text{mm}$ hole or $6\text{mm} \times 18\text{mm}$ slot in the standard 30mm upstand (as in CWT) will be fixed to the existing vertical structure and the other end is embedded to the outer masonry. The drip feature of the tie can be fabricated according to customer requirements, and should be pointed downside during installation to prevent the moisture from crossing between the masonry.

Strip

Length mm	Width mm	Thickness mm	Qty./Box Piece
150	20 up to 50	1.5/2.0/2.5/3.0	250
175	20 up to 50	1.5/2.0/2.5/3.0	250
200	20 up to 50	1.5/2.0/2.5/3.0	250
225	20 up to 50	1.5/2.0/2.5/3.0	250
250	20 up to 50	1.5/2.0/2.5/3.0	250
300	20 up to 50	1.5/2.0/2.5/3.0	250

* Custom designs are available upon request.



CWT

Cavity wall tie bolt/screw-on

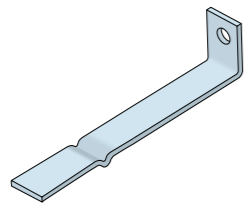

CWT-ST

Cavity slot tie

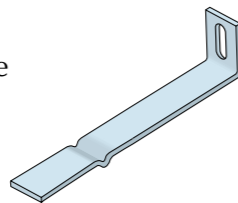

LPS-SC

L- Perforated bolt/screw-on special cavity tie

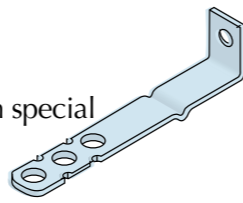

LPS-STC

L-Perforated slot special cavity tie

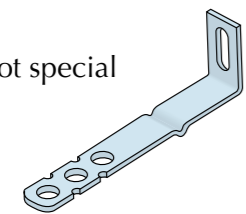

LS-T

L-Slot tie with twist

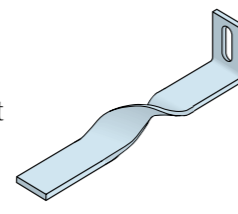

PCWT

Two Side perforated cavity wall tie

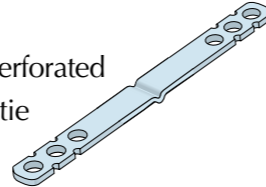

FS2F

Two side split twist tie

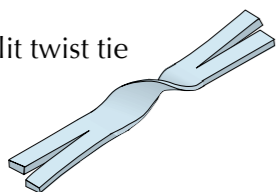

FCWT

Flat two side split end cavity wall tie

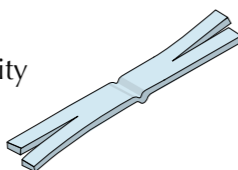

SCT

Safety cavity tie

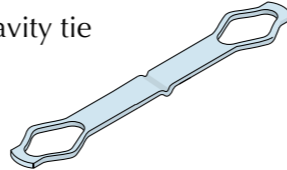

Wire

Reference	Length mm	Diameter mm	Qty./Box Piece
DTW-SD	150/200/250/300	3.0/ 3.5	250
DTW-DD	150/200/250/300	3.0/ 3.5	250
WTZ	150/200/250/300	4.0/ 5.0/6.0	250
WTB	150/200/250/300	3.0/ 3.5	250
ZWT	150/200/250/300	3.0/ 3.5	250

* Custom designs are available upon request.

* Material - Galvanized, Stainless steel, mild steel.

* Finish - Hotdip galvanized, Powder coated

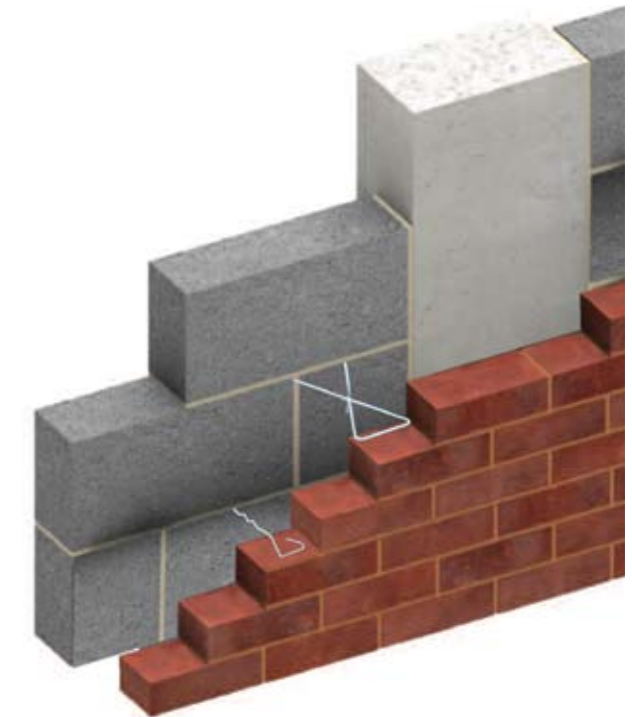

DTW-SD

Double triangular wire tie single drip

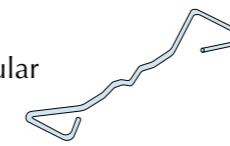

DTW-DD

Double triangular wire tie double drip

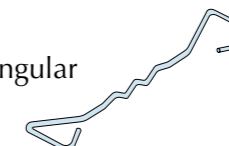

WTZ

Z-Shape Wire tie

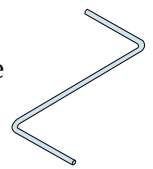

WTB

Butterfly wire tie

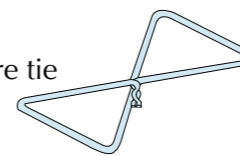

ZWT

Z-Wire Tie

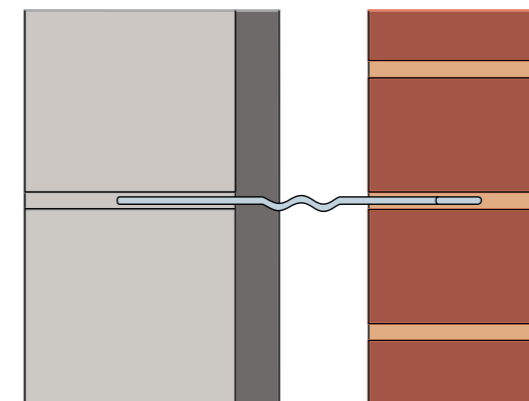
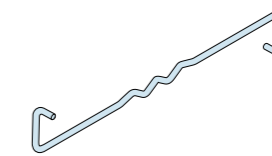

Embedment Length of Tie

The tie should be of perfect length so that it should be properly embedded in masonry. TMI suggest a minimum embedment of 50 percentage in each block.

Overhead Restraints

Application

Overhead restraints are designed for restraining the free standing wall with the overhead structure. The sliding tie is fixed to the overhead structure to arrest side movements. The shrinkage or thermal movement of the wall can be absorbed by the vertical movement of the sliding tie.

Fixing

The sliding tie is provided with a $\varnothing 6\text{mm}$ hole (as in VM1, VHM-ST1) or 6mmx18mm slot (as in VM2, VHM-ST2) as a standard for fixture to the overhead structure. The other end is held between the brick or block work.

Reference	Length mm	Width mm	Thickness mm	Qty./Box Piece
VM	200	35	1.5	250
VM-ST	200	35	1.5	250
VHM	200	35	1.5	250
VHM-ST	200	35	1.5	250
WTCW	150/200/250	25	1.5/2.0/2.5/3.0	250

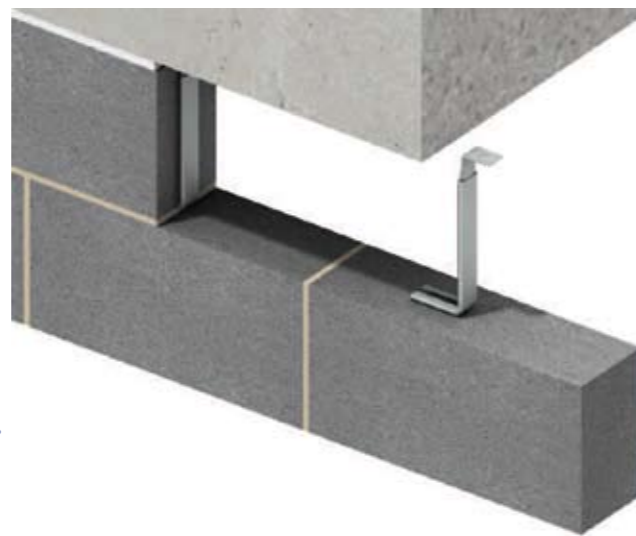

- * Table Shows details about sleeve. Tie will be supplied accordingly to sleeve design.
- * Custom designs are available upon request.
- * Material - Galvanized, Stainless steel, mild steel.
- * Finish - Hotdip galvanized, Powder coated

VM1
Vertical movement tie bolt screw-on

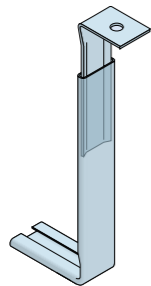

VHM-ST1
Vertical horizontal movement tie slot

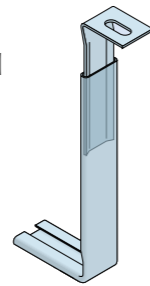

WTCW
Ceiling wall strap tie

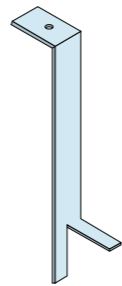

VM2
Vertical movement tie bolt screw on

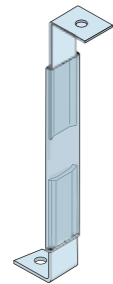

VHM-ST2
Vertical horizontal movement tie slot

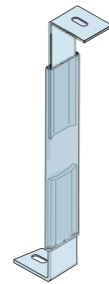

Anchor Plates

Different anchor plates are also available as a simple and economical head restraint system. Anchor Plates are used to attach structural members to concrete structure. Anchor plates and angles can be used to frame openings in concrete walls or as shelf angles.

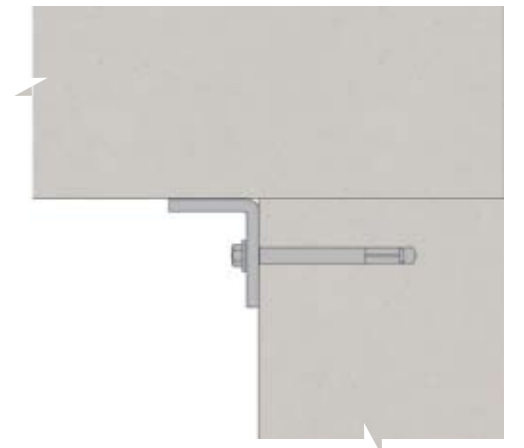
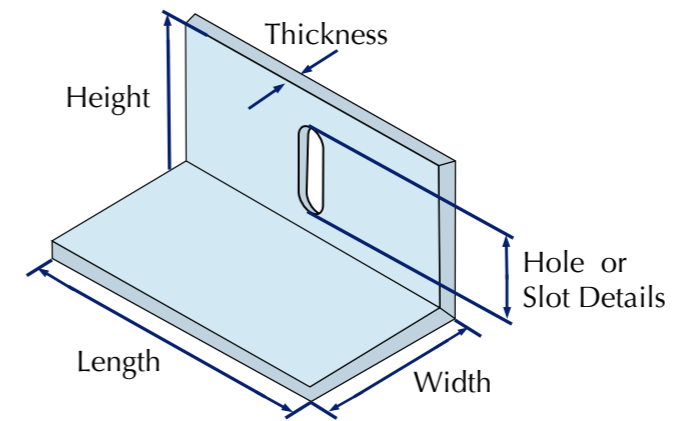

- * Custom designs are available upon request.
- * Material - Galvanized, Stainless steel, mild steel.
- * Finish - Hotdip galvanized, Powder coated

AWS
Anchor with support

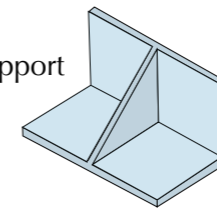

ASP2
2 Side screwed punched anchor.

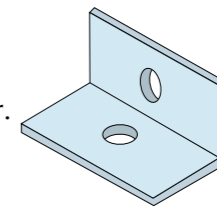

AH-2ST
2 Side slot anchor horizontal

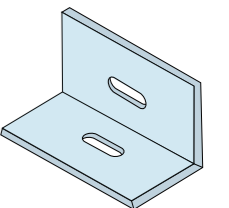

AP
Plain anchor

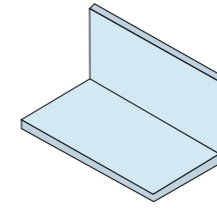

ABS1
1 Side bolt anchor

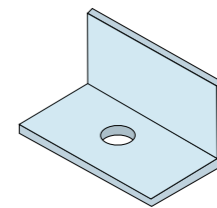

AH-1ST
1 Side slot anchor horizontal

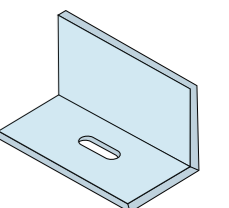

AV-2ST
2 Side slot anchor - vertical

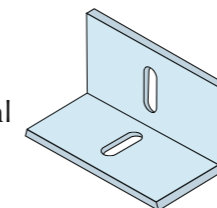

AV-1ST
1 Side slot anchor Vertical

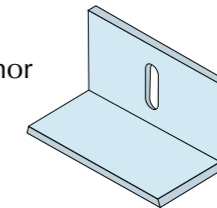

ASB
Bolt / slotted anchor

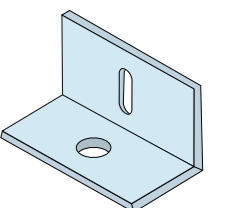

Channels

Application

This system is designed to join and provide lateral support to the newly formed masonry with the existing vertical structure, that is steel section or concrete.

Fixing

The system consist of channel that is fixed to the vertical structure (steel work or a concrete structure) and the tie which slides vertically in the channel embeded to masonry which provides the necessary restraint.

The tie can be supplied with or without rubber sleeves.

Reference	Fixing	Channel Size mm	Available Length mm
OC	Surface Fixing	24x8	100/150/300/3000
DTT	Surface Fixing	30x25	100/150/250

* Material - Galvanized, Stainless steel, mild steel.

* Finish - Hotdip galvanized, Powder coated

OC

Omega channel



DTT

Dove tail with triangular channel

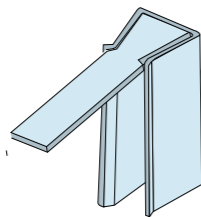

Reference	Fixing	Channel Size mm	Available Length mm
FTC	Surface Fixing	35x14	100/150/300/3000
WTRC	Surface Fixing	35x14	100/150/300/3000

* Material - Galvanized, Stainless steel, mild steel.

* Finish - Hotdip galvanized, Powder coated

FTC

Fasttrack channels

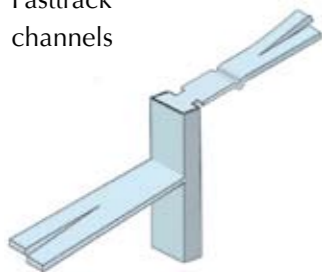

WTRC

Rectangular channel with tie

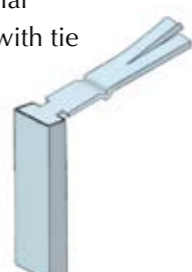

Dove Tail Anchor channels

The dove tail Anchor channel is cast-in to the concrete during construction and after setting, the wire or strip tie is mated and embeded to the masonry which provides a support to the structure. The dove tail anchor channel to be furnished with form filler inserts to protect channel from filling with concrete during installation.

Reference	Fixing	Channel Size mm	Available Length mm
DTCV-W	Cast-in	25.4x25.4	3000
DTCV-S	Cast-in	25.4x25.4	3000
DTCH-W	Cast-in	25.4x25.4	3000

* Wire diameter - Ø4 up to Ø6 .

* Material - Galvanized, Stainless steel, mild steel.

* Finish - Hotdip galvanized, Powder coated

DTCV-W

Dovetail anchor channel vertical with wire Tie



DTCV-S

Dovetail anchor channel vertical with strip Tie



DTCH-W

Dovetail anchor channel horizontal with wire Tie



Sliding Anchor Systems

Application

Sliding anchor system is designed to restrain cavity wall to the overhead structure.

Fixing

The system has a stem fixed to the overhead structure. It accepts ties which slide to accommodate vertical movement.

Stem Specification

Length mm	Width mm	Thickness mm	Qty./Box Piece
300 up to 600	25	4	250

* Head option as shown and can be fabricated according to customer requirements.

Tie Specification

Reference	Length mm	Width mm	Thickness mm	Qty./Box Piece
SAT-TW	200/250/300	25	2	250
SAT-OW	150	25	2	250

* Other length are available upon request.

* Material - Galvanized, Stainless steel, mild steel.

* Finish - Hotdip galvanized, Powder coated

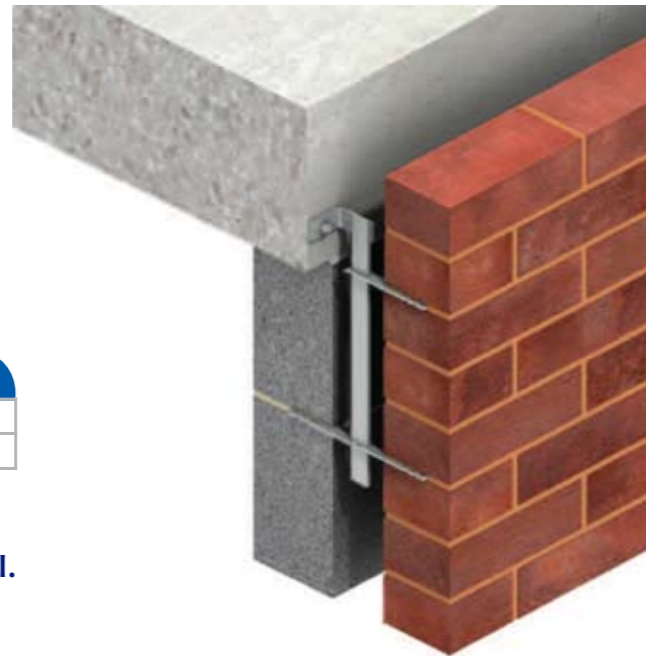

- SAS-H1**
Sliding Anchor Stem - Head One
- SAS-H2**
Sliding Anchor Stem - Head Two
- SAS-H3**
Sliding Anchor Stem - Head Three
- SAS-H4**
Sliding anchor stem - head four
- SAS-H5**
Sliding anchor stem - head five
- SAS-H6**
Sliding anchor stem - head twist

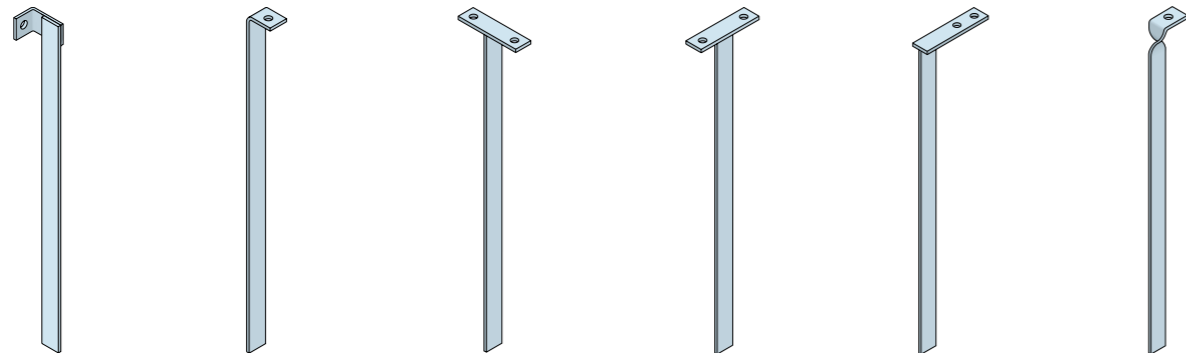

SAT-TW
Slidding Anchor Tie - Two Way

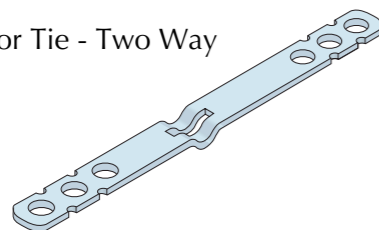

SAT-OW
Slidding Anchor Tie - One Way

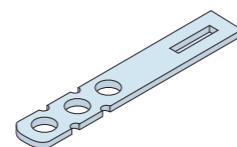

Wall Ties Guide

Different combinations is available from the listed head, body and tail options to suit your practical applications.

Tail Options

TPE

Plain end

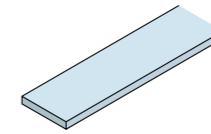

TSE

Split end

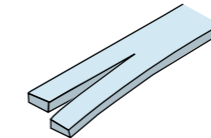

TP

Perforated

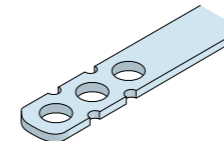

TC

Corrugated

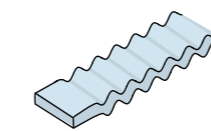

TSB

Split bend end

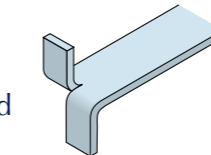

TBE

Bend end

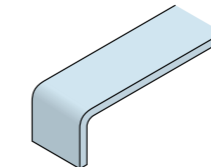

THE

Hole end

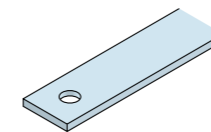

TSE

Safety end

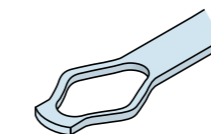

Body Options

BPE

Plain

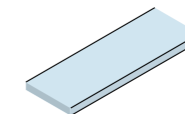

BD

Drip

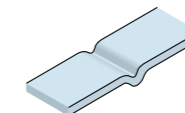

BT

Twist

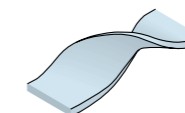

Head Options

HUH

Upstand with hole

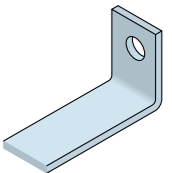

HUS

Upstand with Slot

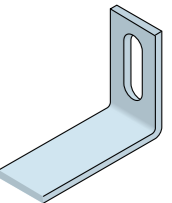

HSE

Split end

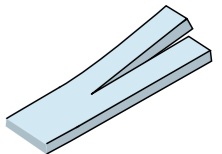

HP

Perforated

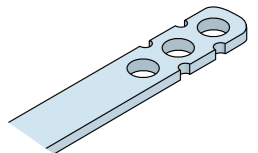

HDT

Dove tail

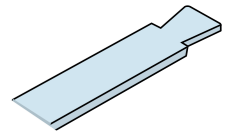

HOP

Obround profile

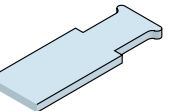

HOP

Rectangular profile

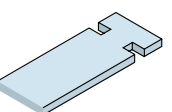

HSE

Safety end

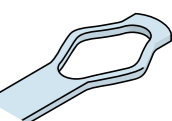

* For placing an order, please provide relevant information to the inquiries below.

Head Option	Body Option	Tail Option	Size	Material	Qty

